

RING BLOW Water-resistant Series



CAUTION

- Read the instruction manual carefully before you install, put into operation and maintain the Ring Blow and handle it properly.
- For the sake of safety, never modify the Ring Blow.
We take no responsibility for the troubles caused by repairing or modifying the product.
- Hand over this instruction manual surely to the end users, who actually install, operate and maintain the Ring Blow.
- After having read the instruction manual, keep it at the place, where can be accessed by the persons, who use it.
- The specification of the product may be changed without prior notification.

Introduction -----

Thank you for your purchasing of the Ring Blow.

It is required for the Ring Blow for give full play to its performance, for preventing troubles from occurring and for continuing its satisfactory operation for a long period not only to maintain and inspect it after putting it into service but also to handle it properly in every stage after its delivery until its actual operation.

This instruction manual illustrates the essential items for handling the Ring Blow.

If you find any question, please inquire of our special agent, dealer or business office about it.

Cautions for safety -----

- Read this instruction manual and the other attached documents carefully before you use (install, transport, maintain, inspect etc.) the Ring Blow and then use it properly. Acquire first the machine knowledge, safety information and all caution items and use the machine.
Keep this instruction manual at the place, where can be accessed by the persons, who use it.
- The ranks for safety items are classified into alarms and cautions and described in this instruction manual.



: those items, for which the possibility of human **DEATH** and **HEAVY INJURY** are feared, if they are mishandles.



: those items, for which hazardous condition may occur and **MEDIUM HAZARD** and **SLIGHT INJURY** are feared and/or material damage are feared, if they are mishandles.

Even those items marked with

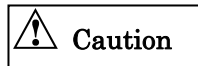

may lead to serious results depending upon the situation.

As every item describes serious contents, be sure to keep it always.

Furthermore, the following symbols are applied according to necessity in this instruction manual, so that the essential points of indication can be grasped at a glance.

Symbol	Meaning
	Notification of a general prohibition
	Always connect a grounding terminal!
	Take care of an electrical shock!

Symbol	Meaning
	Do not touch!
	Take care of ignition!
	Take care of a high temperature!



Alarm

General	<ul style="list-style-type: none">• The works of transport, installation, piping, wiring, operation, control, maintenance and inspection may only be executed by the experts, who are well skilled of handling the Ring Blows. Otherwise, an ELECTRIC SHOCK, an INJURY or a FIRE is feared.• Hot line works are forbidden. Work always with the power supply switched off. Otherwise, an ELECTRIC SHOCK or a FIRE is feared.• Do not use the Ring Blow in an explosive atmosphere. Otherwise, an INJURY or a FIRE is feared.
Installation, Adjustment	<ul style="list-style-type: none">• Ground the grounding terminal surely. Otherwise, an ELECTRIC SHOCK or a FIRE is feared.• In the Ring Blow is used as mounted on a ceiling or a wall, its fall is feared depending on its mounting condition. Observe the catalog or instruction manual for the details of usable range. An INJURY due to a FIRE is feared.
Piping, Wiring	<ul style="list-style-type: none">• Connect it to the power supply cable according to the wiring diagram within terminal box and the instruction manual. An ELECTRIC SHOCK or a FIRE due to incorrect connection is feared.• Use it always at the voltage and frequency indicated in the nameplate on its main body. A BURNOUT or a FIRE is feared.• Do not bend, stretch or pinch the power supply cable and the lead wire for the Ring Blow by force. An ELECTRIC SHOCK or a FIRE is feared.• Restore the cover for terminal box to the original position after completion of every work. Otherwise, an ELECTRIC SHOCK is feared.• Dismount the emblem for middle bracket surely before installing the main body. Otherwise, a BURN or an INJURY is feared.
Operation	<ul style="list-style-type: none">• Never access or touch any rotating body (cooling fan etc.) during running. A CATCH-IN on an INJURY is feared.• Switch off the power supply always in case of power failure. An INJURY is feared due to sudden work of the machine at restoration of power supply.• Switch off the power supply always when the Ring Blow is stopped because the protection unit belonging to it worked. An INJURY is feared due to sudden work of Ring Blow at recovery of the protection unit.



Caution

General	<ul style="list-style-type: none">• Do not use the Ring Blow out of the specifications described in the nameplate, catalog and instruction manual. An ELECTRIC SHOCK, an INJURY or a DAMAGE is feared.• Do not use the damaged Ring Blow. An ELECTRIC SHOCK, an INJURY or a FIRE is feared.• Do not insert any foreign material or finger into the opening (opening in fan cover, admission and discharge ports) of Ring Blow. An ELECTRIC SHOCK an INJURY or DAMAGE is feared.• We take no responsibility for modification by the customer, as they are out of the scope of our responsibility.
---------	--





Caution

Transportation	<ul style="list-style-type: none"> • Take full care of fall and tumbling down during transportation. An INJURY is feared. • Lift up the Ring Blow equipped with a hanger bolt always after getting rid of loosening of the hanger bolt. But after mounting the Ring Blow on a machine, do not lift up the entire machine using the mounted hanger bolt. Verify the mass of motor based in the nameplate, package box, outline drawing, catalog or the like before lifting it and do not lift any more mass than the rated load of lifting tool. Exert tension gradually on the wire and do not lift up suddenly. This lift-up work may only be executed by the qualified workers. Do not stay under the Ring Blow during the lifting work. An INJURY or FIRE caused by FALL or TUMBLING DOWN is feared for all of these cases.
Opening the Package	<ul style="list-style-type: none"> • Open the package after verifying the top and bottom of product. An INJURY is feared. • Open the wooden frame package taking care of the used nails. An INJURY is feared. • Verify if the product is just the ordered one. An INJURY, DAMAGE or a FIRE due to use of the incorrect product is feared.
Installation, Adjustment	<ul style="list-style-type: none"> • Never place any inflammable material around the Ring Blow. A FIRE is feared. • Do not place any obstacle against ventilation around the Ring Blow. A BURN or a FIRE caused by abnormal heating due to disturbed cooling is feared. • Fasten the foundation bolts surely. Insufficient fastening may cause an INJURY and DAMAGE due to shift of the Ring Blow. • Never get on or hang on the Ring Blow. An INJURY is feared. • Ring Blow shell be always mounted on suitable place in order to see its nameplate easily and do not put any obstacle in front of it. Do not dismount the nameplate.
Piping, Wiring	<ul style="list-style-type: none"> • Construct the piping and wiring according to the technical standard for electrical equipment and the internal wiring provisions. A BURNOUT or a FIRE is feared. • For wiring to the terminal base in terminal box, fasten the terminal screws with a torque of 1.0 to 1.3 N · m. Otherwise, DAMAGE of the terminal box is feared. • For measuring the insulation resistance, do not touch the terminal. An ELECTRIC SHOCK is feared. • No protection unit belongs to the Ring Blow except for some models. The installing of overcurrent protection unit is obliged based upon the technical standard for electrical equipment. For preventing a FIRE and DAMAGE due to a motor burnout, we recommend to install the protection unit other than overcurrent protection units (including a ground fault interrupter) based upon consulting with us.
Operation	<ul style="list-style-type: none"> • If any abnormality occurs, stop the operation immediately and switch off the power supply. An ELECTRIC SHOCK an INJURY or a FIRE is feared. • The Ring Blow becomes considerably hot during its operation. Take care not to touch it by your hand or body. A BURN is feared. • Do not insert your finger or any others material into the opening of Ring Blow. An ELECTRIC SHOCK an INJURY or FIRE is feared.

 Caution	
Maintenance , Inspection	<ul style="list-style-type: none"> Do not touch the terminal for measuring the insulation resistance. An ELECTRIC SHOCK is feared. The Ring Blow becomes considerably hot during its operation. Take care not to touch by your finger and body. A BURN is feared. Take care, if you use a solvent or the like for cleaning the Ring Blow. A POISONING is feared. Further, the use of thinner or benzene may cause discoloring or exfoliation of coating on the Ring Blow.
Disassembly, Repair, Modification	<ul style="list-style-type: none"> The repair, disassembling and modification shall be executed only by experts. An INJURY due to the edge of Impeller or key groove, an ELECTRIC SHOCK or a FIRE is feared.
Disposal	<ul style="list-style-type: none"> Handle the Ring Blow as a general industrial waste, when it is be disposed.



Package Opening and Product Verification -----

When the Ring Blow has been delivered, verify the following points.

 Caution	
	1. Verify the top and the bottom of product and open the package. Otherwise, an INJURY is feared.
	2. Open the wooden frame package, taking care of used nails. Otherwise, an INJURY is feared.
	3. Verify if the delivered product is just the ordered one. (Check the output voltage, frequency, model etc. with the description on face plate.) An INJURY , DAMAGE or a FIRE is feared, if an incorrect product is used.
	4. Verify if any part is damaged and if any bolt or nut is loosened during the transport.

Transport-----

Take care of the following points for transporting the Ring Blow.

 Caution	
	1. Take full care of fall and tumbling down during transport. An INJURY is feared.
	2. Lift up the Ring Blow equipped with hanger bolts always after getting rid of loosening of the hanger bolts. But after mounting the Ring Blow on a machine, do not lift up the entire machine by means of the hanger bolt. Verify the mass of Ring Blow based on the face plate, package box, outline drawing, catalog etc. before lifting it and do not lift any more mass than the rated load for lifting tool. Exert tension gradually on the wire and do not lift up the mass suddenly. This lift-up work shall be carried out only by qualified workers. Do not stay under the Ring Blow during lifting work. An INJURY or a DAMEGE caused by FALL or TUMBLIND DOWN is feared for all of these cases.

Safekeeping-----

Take care of following points for safekeeping the Ring Blow or suspending its operation for a long period.

1. For safekeeping in the packed.

Keep the Ring Blow in an indoor dry place. Do not keep it on such a place, as is exposed to water or dust, or with vibration, or place it on a bare ground directly.

2. For keeping it in the installed condition.

- (a) Cover the entire Ring Blow with a sheet for protecting it from invasion of moisture foreign materials.
- (b) Keep the Ring Blow with its hanger bolt mounted. If it is kept with the hanger bolt dismantled, water may sometimes invade into through the screw hole.
- (c) Run the Ring Blow for some minutes keeping it and every 3 months, for protecting the bearings from rusting.
- (d) If the operation of Ring Blow is suspended for a long period, measure the insulation resistance of its winding every 6 months and verify that it is kept at higher than 1 M Ω . If the resistance is not higher than 1 M Ω at normal temperature, such measures are required as to dry the winding.

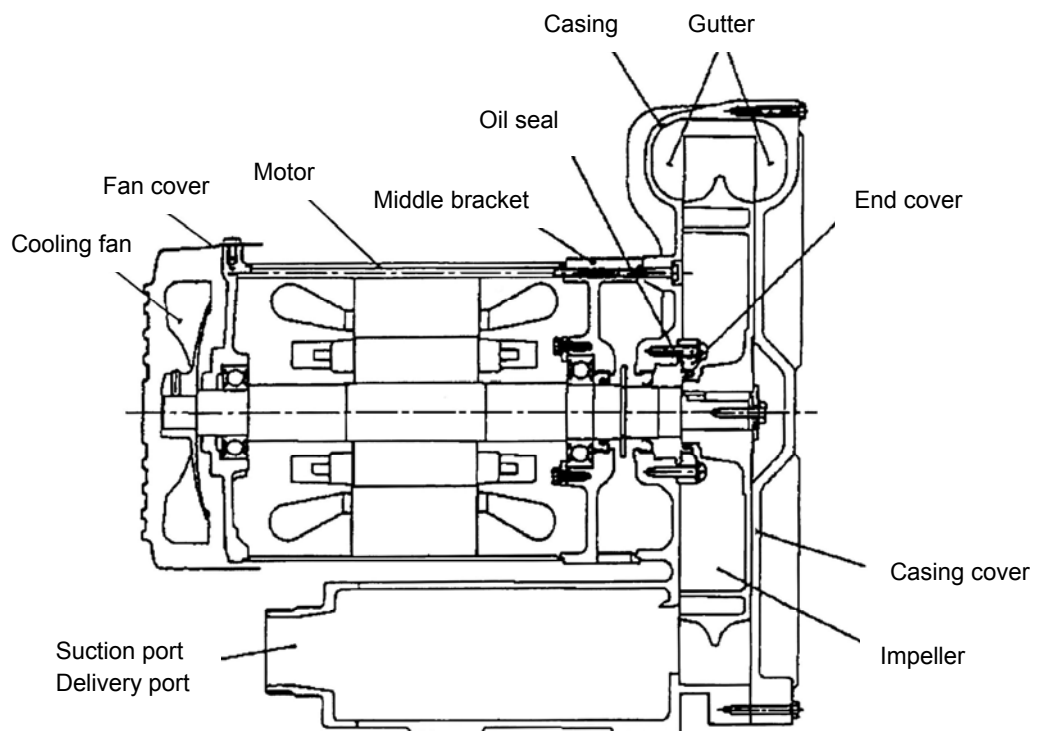

Name of parts-----









(Figure 1)







Installation and Piping -----

1 Take care of the following points for installing and adjusting the Ring Blow.



 Alarm	
 	<p>1. Ground the grounding terminal surely. An ELECTRIC SHOCK or a FIRE is feared.</p> <p>2. In case of using the Ring Blow mounted on a ceiling or wall, its fall is feared depending upon the condition. Follow the catalog or instruction manual for details of usable range. INJURY caused by its FALL is feared.</p>

 Caution	
    	<p>3. Never place any inflammable object around the Ring Blow. A FIRE is feared.</p> <p>4. Do not place any obstacle, which disturbs the ventilation, around the Ring Blow. A BURN or a FIRE caused by abnormal heating are feared, due to the disturbed ventilation.</p> <p>5. Fasten the foundation bolts surely before starting the operation. An INJURY or DAMAGE due to shift of the Ring Blow is feared, if the fastening is insufficient.</p> <p>6. Never step on or hang from the Ring Blow An INJURY is feared.</p> <p>7. Make the nameplate for the Ring Blow always easily legible and do not place any obstacle in front of it. Do not dismantle the face plate.</p>

2 Take care of the following ranges for the installation site and the gas to be transported.

 Caution	
	<p>1. Outdoor/indoor: Install at an indoor site, which is exposed to no wind and rain Otherwise, an ELECTRIC SHOCK or a FAULT is feared.</p>
	<p>2. Ambient temp: Use it in 40°C or less. Otherwise, shortening of life and a FAULT is feared. (No freezing is allowed.)</p>
	<p>3. Relative humidity: Use it in 80% or less. Shortening of life or FAULT is feared.</p>
	<p>4. Atmosphere / gas to be transported: If can neither be used in a place, where any such corrosive liquid or gas as an acid or an alkali or any inflammable or explosive gas exists, nor transport such material. A FIRE, a FAULT or a INJURY is feared.</p>
	<p>5. Dusts: Evade a place, where a lot of dusts, wastes or thread chips exist. If inevitable, clean the dusts and wastes adhered in the blower regularly. A FIRE or a FAULT is feared</p>
	<p>6. Ventilation: Select a well ventilated place. It shall not be used in a closed room or in a case. A FIRE, a BURN or a FAULT is feared.</p>

⚠ Caution

	7. Ambient air:	Evade a narrow place, for the convenience of maintenance and inspection.
	8. Vibration:	Select a place, where no external vibration is added to the blower. If inevitable, take anti-vibration measures for protecting from addition of vibration the blower. A FAULT , DAMAGE or an INJURY is feared. The value in Figure 1 is recommended as the tolerable vibration value.
	9. Handling gases:	The temperature of handling gases should be kept in the range from 0 to 40°C. Handling gases containing moisture (99% humidity) permitted. The blower is of water-resistant construction, however a water tank to separate air and water should be installed. The blower cannot be used for handling combustible, corrosive and explosive, gas as well as air. A FIRE , a BURN or a FAULT is feared.

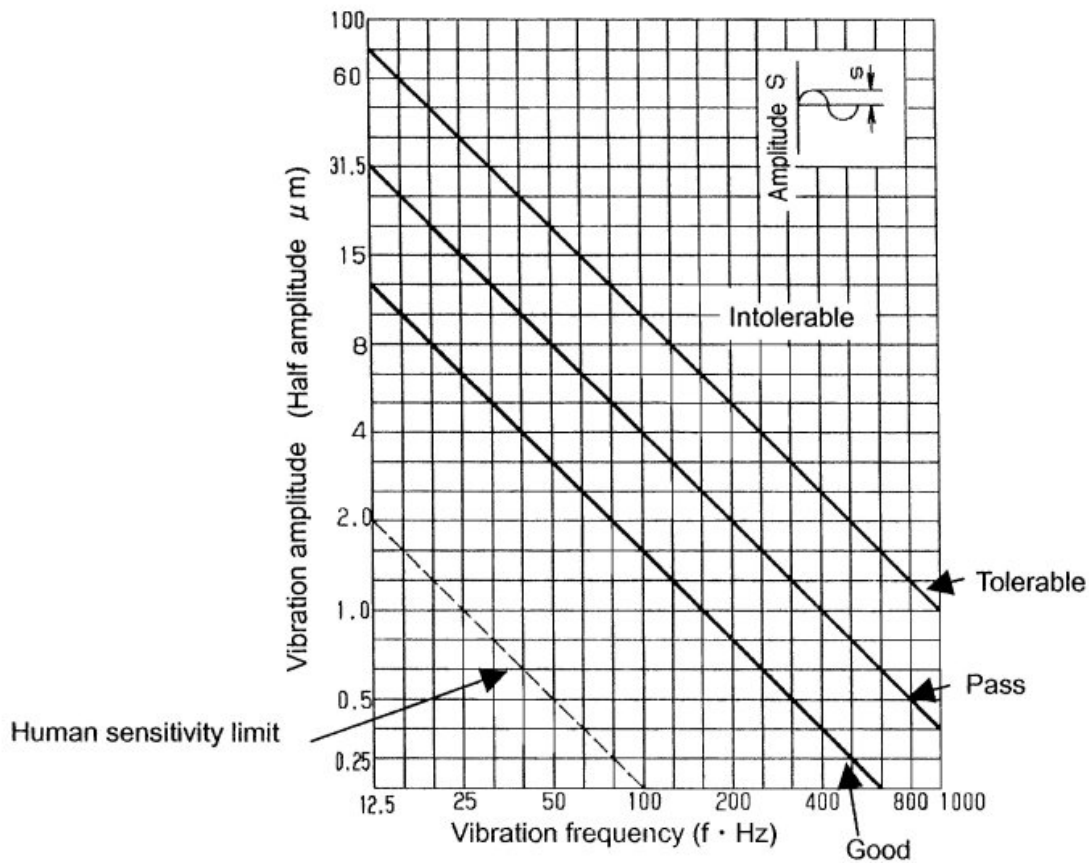

10. The Ring Blow should be install horizontally only. If using vertical installation, liquid might stuck inside and cost further damage of the Ring Blow. (Figure 2).

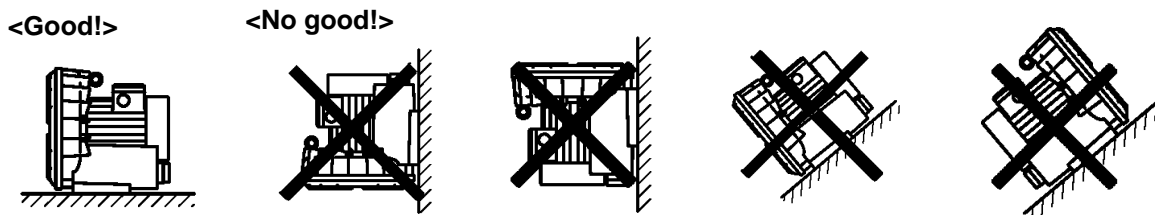

(Figure 2)

- Use such pipes as PVC-pipes, gas pipes, flexible hoses etc., which can hold the Ring Blow pressure and hoses other than metallic one for discharge side, use those once, which have a sufficient high-temperature resistance.

Lay piping so surely as to have no leakage (Figure 3).

Kind of piping for suction port and delivery port.

Types exclusively used for house

Type for house and screwed pipes

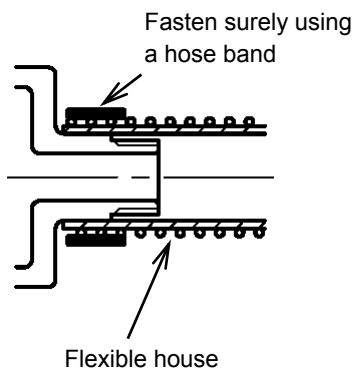
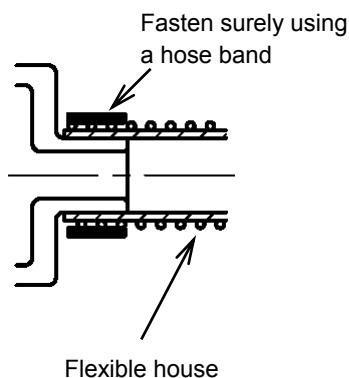

Piping for Ring Blow

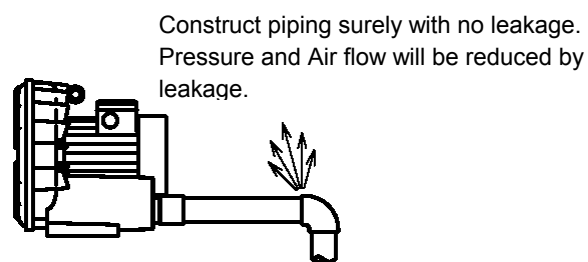
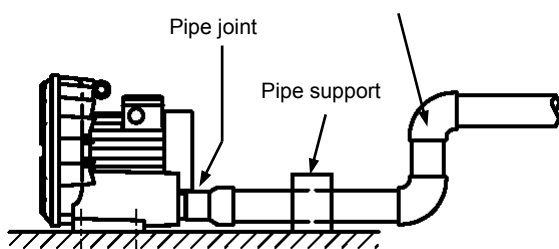
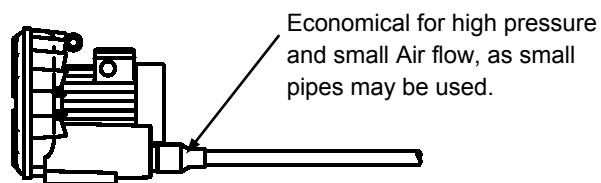
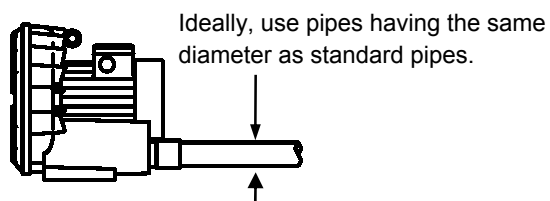

Caution : Arrange pipe-supports properly, so that no self weight and external load concentrate on pipe connections.





(Figure 3)









- Do not allow any foreign material to intrude into the blower.

- The rotation direction shall be the arrow direction on the casing. The rotation direction can be seen at the shaft end at counter-blower side and it is also correct, if the wind direction coincides with the IN and OUT indicated at the pipe connection port. Reverse rotation is allowed, although the performance is reduced.

Operation -----

Verify the following points for operating the Ring Blow.

 <h2 style="display: inline;">Alarm</h2>	
  	<ol style="list-style-type: none"> 1. Never access or touch the rotating body (cooling fan etc.) during running. CATCH-IN or INJURY is feared. 2. Turn the power supply switch off in case of power failure. INJURY is feared, when the machine runs suddenly at the power restoration. 3. Be sure to turn the power supply switch off, in the Ring Blow has been stopped because the attached protection unit has been activated. An INJURY is feared, as the machine may run suddenly at the power restoration.

 <h2 style="display: inline;">Alarm</h2>	
      	<ol style="list-style-type: none"> 4. If any abnormality occurs, stop the operation immediately and turn the power supply switch off. An ELECTRIC SHOCK, an INJURY or a FIRE is feared. 5. During operation the Ring Blow, it becomes considerably hot. Take care not to touch by your hand or body. A BURN is feared. 6. During its operation, do not insert your finger or any other object into the opening (fan cover, admission and discharge ports etc.) of the Ring Blow. An ELECTRIC SHOCK, an INJURY or a FIRE is feared. 7. If the Ring Blow (VFZ401A and larger) is operated with the discharge side closed, the motor and blower temperature rises drastically and its distortion or damage after long time operation is feared. 8. If the Ring Blow is operated at a wind flow rate not more then continuous operation range, the motor and blower temperature rises drastically and its distortion or damage is feared, if the operation is continued for along time. 9. The temperature of the air passing through the Ring Blow rises. Especially it reaches a high temperature at a nearly closed condition. Take care not to touch it by your hand or body. A BURN is feared. Figure 6 shows the temperature rise. 10. During its operation, the Ring Blow and discharged air will reach a considerably high temperature. Do not use it in a narrow closed room. A BURN, a FIRE or DAMAGE is feared. (Inquire of us, if you use it in closed operation.)

- The Ring Blow will be continuously at within the operation range shown on the wind flow rate to static pressure curve (shown in the catalog). This operation range is so wide that the machine can be operated at nearly closed pressure but, if you operate it at high pressure, especially take care not to exceed the operation range. If you must operate it at closed condition, arrange a bypass hole on the way, so that a more wind than required range flows through the blower even if the suction port is closes (Figure 4).

For using with the discharge side closed

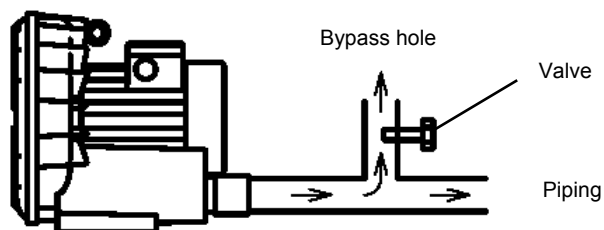

(Figure 4)

- For using air intermittently, the switching by means of a valve is recommended rather than the switching on and off of the motor (Figure 5).

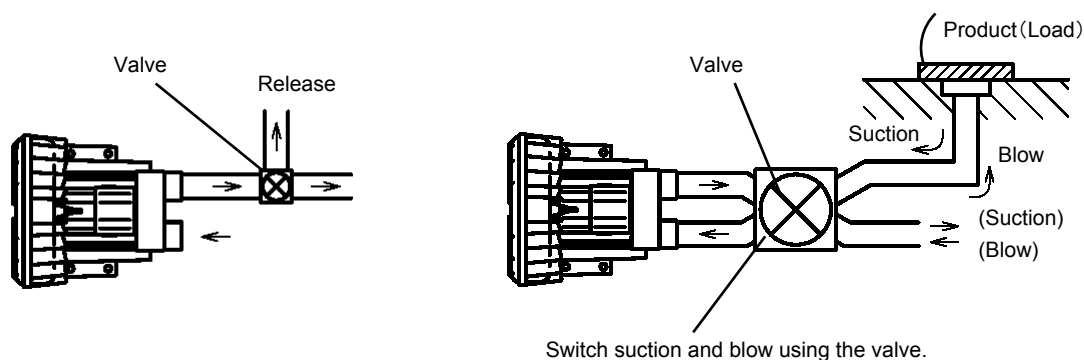

(Figure 5)

- The characteristics differ a little when the machine is used at suction side and when used at discharge side, as shown in the characteristics curve. As the air specific weight becomes larger, when the discharge side is throttled, the static pressure becomes also larger.
- Remove any solid object, dust, thread chip, water drop or the like before entering into the Ring Blow. Even if make no dust be sucked directly, take measures not to suck any dust staying around by mistake. Use of the dust staying around by mistake. Use of the dust collection sack in a vacuum cleaner or the like is recommended. Also, it is recommended to use a filter having considerably large space. Remove sometimes the dust collected in the filter. It may also be possible to make the dust blow off by reversing the Vacuum Pump, if it is possible.
- The Ring Blow is of water-resistant construction, however a water tank to separate air and water should be installed.
- If dusts adhered inside and outside of the blower (especially in the cooling air path for cooling fan cover), remove them. If adhered dusts increase, it causes such troubles as a temperature rise, a sink of wind flow rate and an increase vibration.
- As the motor load (current) changes depending upon the air flow used by the Ring Blow, refer to the characteristics curve for setting the wiring capacity and protection relay.
- The bearing, oil seal and silencer are consumables and need to be changed when their lives are arrived. Depending on the environment, in which the machine was used, the Impeller, casing, casing cover, and wire net are also included in consumables.

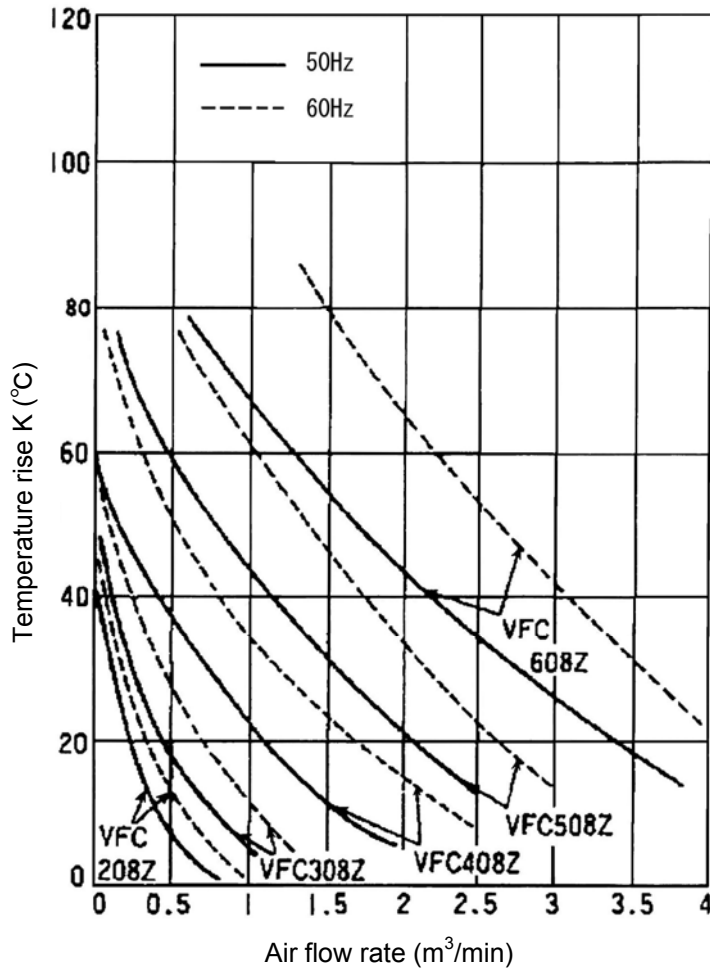

(Figure 6) Discharged air-temperature rise curve

Faults and Countermeasures

In case of occurrence of any fault in the Ring Blow, handle it properly referring to Table 1 “Fault States of Ring Blow and Countermeasures” (page 12) and taking care of the following points.

 <h1 style="margin: 0;">Caution</h1>	
 	<ol style="list-style-type: none"> 1. Always only the expert shall investigate, repair, disassemble and modify the fault. An INJURY due to the Impeller edge or key groove, an ELCTRIC SHOCK or a FIRE is feared. 2. If the Ring Blow must be abandoned as the result of investigation in a rare possibility, dispose it as a general industrial waste.

3. If the investigation result shows that the machine cannot be easily repaired, if you will request any spare part or you have any trouble, contact our agent, dealer or business office at any time. In case of contacting us, please verify following items in advance:
 - (a) Model indicated in the nameplate,
 - (b) SER. No.,
 - (c) Details of the fault,
 - (d) Name of faulty part, name of spare parts,
 - (e) Required quantity and
 - (f) Kind of gas to be transported (e.g. Air)

Table - 1 Fault States of Ring Blow and Countermeasures

States of Fault		Causes	Countermeasures
Does not rotate	Whining sound	Switch-contact fault	Repair switch-contact.
		Fuse blown	Replace it.
		One phase of power supply connection wires disconnected.	Replace it.
		One phase of stator coils disconnected.	Request factory to repair it.
		Stator and rotor come into contact due to bearing fault.	Replace bearing.
		Foreign material involved in blades.	Remove it.
	No sound	Power failure	Consult with utility company.
		2 phases of power supply connection wires disconnected.	Replace them.
		2 phases of stator coils disconnected.	Request factory to repair them.
		Switch fault	Replace or replace it.
Rotates	Fuse blown	Insufficient fuse capacity	Replace it with larger capacity.
		Short-circuit in circuit	Repair or replace it.
	Motor overheated	Power supply voltage fell	Consult with utility company.
		Single phase operation	Request factory to repair it.
		Impeller rubbing	Adjust wheel.
	Whining sound	1 phase short circuit in stator coils.	Request factory to repair it.
		Uneven space between stator and rotor.	Request factory to repair it.
	Abnormal noise	Blade wheel rubbing	Adjust it.
		Blade damaged due to foreign material.	Request factory to repair it.
		Bearing fault	Replace it.
	Motor rotates but fan works improperly.	Leakage in piping.	Fasten tightly.
		Piping blocked	Ventilate sufficiently.
		Reverse rotation direction	Correct connection (2 out of 3 wires).
		Closure equipment fault	Replace it.

Guarantee Period and Scope of Guarantee -----

<Product guarantee and scope of guarantee>

- The guarantee period of for product shall be 1 year after shipment to the specified destination. If any fault has occurred during the guarantee period in a proper use condition within he product specification range, the faulty part will be exchanged or repaired free of charge.
- However, if the fault corresponds to any of the following cases, it will be excluded from the scope of guarantee:
 - 1) due to improper handling or use by the User
 - 2) due to causes of fault other then of delivered product
 - 3) due to improper repair of modification
 - 4) due to natural calamity or disaster, which does not belong to the responsibility of supplier. The said guarantee means the guarantee for supplied product itself and we take no responsibility for the damage induced from the fault of the product.

<Charged repair>

- The investigation and repair after the expiration of guarantee period will be charged. Even during the guarantee period, we accept the repair of fault and the cause investigation due to reasons out of the scope of guarantee for payment.



Atai Fuji Motor Co., Ltd.

No. 32, Sec. 2, Chang-Hsing Rd., Lu-Chu Dist., Taoyuan City, Taiwan, R.O.C.

TEL: +886-3-321-3030 / FAX: +886-3-321-7890

<http://www.ataifuji.com.tw/>